

- Short wavelength index guided type MQW InGaAlP VLD
- Package flange: $\varnothing 9\text{mm}$
- Applications include:
Bar code scanners, alignment/measurement systems, medical systems, etc.

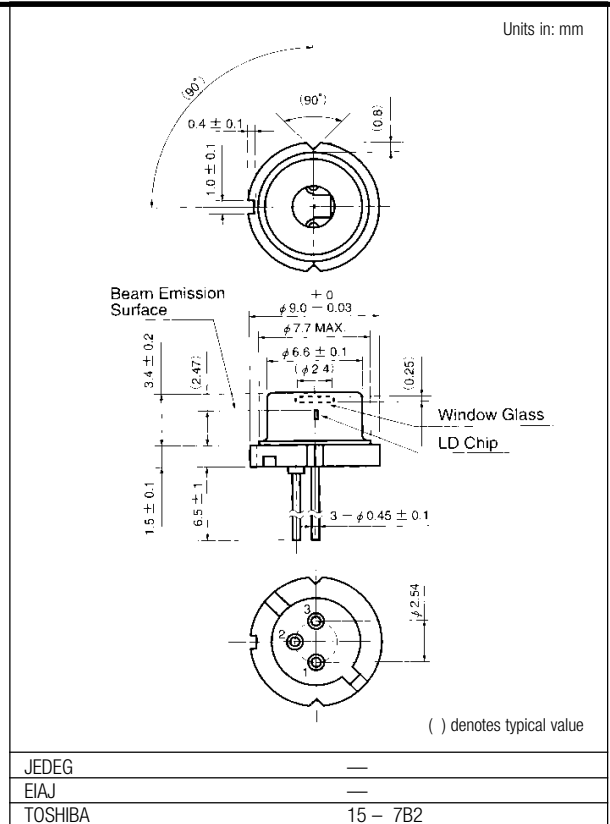
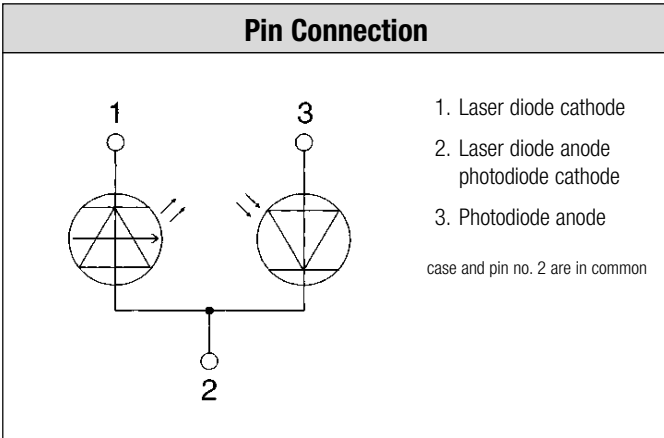

Maximum ratings (Tc=25°C)

Characteristic	Symbol	Rating	Unit
Optical Output Power	P_O	5	mW
LD Reverse Voltage	$V_{R(LD)}$	2	V
PD Reverse Voltage	$V_{R(PD)}$	30	V
Operation Case Temperature	T_C	-10~50	°C
Storage Temperature	T_{stg}	-40~85	°C

Optical-electrical characteristics (Tc=25°C)

Characteristic	Symbol	Test Condition	Min.	Typ.	Max.	Unit
Threshold Current	I_{th}	CW operation	—	45	65	mA
Operation Current	I_{op}	$P_o=5\text{mW}$	—	60	80	mA
Operation Voltage	V_{op}	$P_o=5\text{mW}$	—	2.2	2.8	V
Lasing Wavelength	λ_P	$P_o=5\text{mW}$	640	650	660	nm
Beam Divergence	$\theta_{ }$	$P_o=5\text{mW}$	4	7.5	11	°
	θ_{\perp}	$P_o=5\text{mW}$	25	30	35	°
Monitor Current	I_m	$P_o=5\text{mW}$	0.25	1.1	1.7	mA
PD Dark Current	$I_{D(PD)}$	$V_R=5\text{V}$	—	—	100	nA
PD Total Capacitance	$C_{T(PD)}$	$V_R=5\text{V}, f=1\text{MHz}$	—	—	20	pF

Examples of Typical Characteristics

Optical Output Power vs. Forward Current

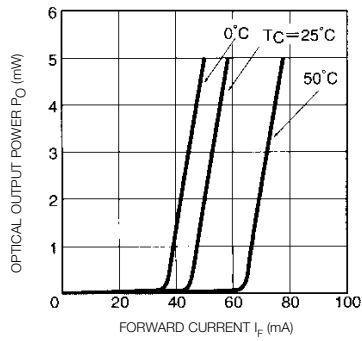

Forward Current vs. Forward Voltage

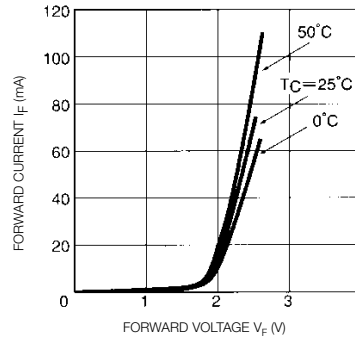

Case Temperature Dependence of Threshold Current

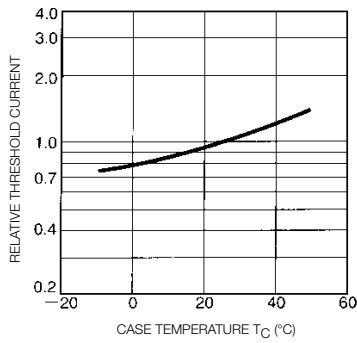

Case Temperature Dependence of Lasing Wavelength

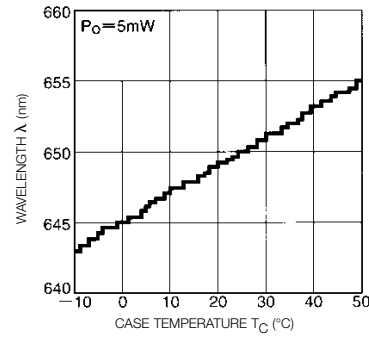

Far-field Patterns

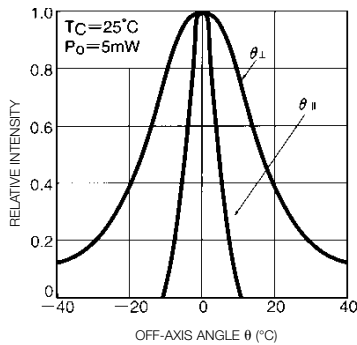

Lasing Spectrum

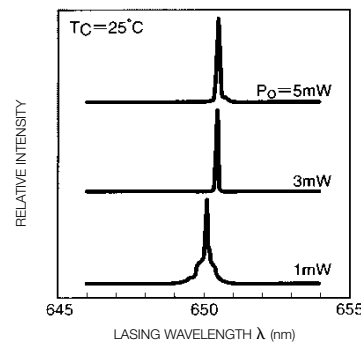

Monitor Current vs. Optical Output Power

